

**BAD BOY  
MOWERS**



# **RENEGADE DIESEL** OUTLAW

## **ZERO-TURN MOWER OWNER'S OPERATOR SERVICE MANUAL**

For additional information, please see us at  
[www.badboymowers.com](http://www.badboymowers.com)



# TABLE OF CONTENTS

Basic Information .....	<b>Section 1</b>	Page 4
Bad Boy Safety Guidelines.....	<b>Section 2</b>	Page 5
Operation .....	<b>Section 3</b>	Page 9
Maintenance.....	<b>Section 4</b>	Page 10
Storage and Transportation.....	<b>Section 5</b>	Page 10
Troubleshooting and FAQ .....	<b>Section 6</b>	Page 12
Controls.....	<b>Section 7</b>	Page 13
Instrumentation .....	<b>Section 8</b>	Page 14
Moving In-operable Mower.....	<b>Section 9</b>	Page 14
Mower Blade Maintenance.....	<b>Section 10</b>	Page 15
Equipment Lubrication.....	<b>Section 11</b>	Page 15
How To Choose the Right Blade .....		Page 16
Mowing Tips.....		Page 17
Service Section .....		Page 18
Parts Section.....		Page 31
Limited Warranty .....		Page 32

Revision: 10-16-20



## **THIS MANUAL APPLIES TO THE FOLLOWING EQUIPMENT:**

### **BAD BOY DIESEL RENEGADE**

Diesel Renegade 61" 403F-11 Perkins Diesel [BRN61247PK]

## **COMMONLY USED ITEMS AND PART NUMBERS**

61" Blade	Hi-Lift Fusion 038-6080-00	Gator Blade 038-6081-00	Wave Blade 038-6090-00
Hydraulic Filter	063-8014-00		
61" Deck Belt	041-0222-00		
Pump Belt	041-8000-00		
Oil Filter	063-2010-00		
Air Filter	Inner Filter 063-2060-00	Outer Filter 063-2050-00	
Fuel Filter	063-2011-00		
Motor Oil	15W-40 Motor Oil - Bad Boy Synthetic Blend Motor Oil Recommended. (Approximately 3.5 Quarts)		
Hydraulic Oil	20W-50 Motor Oil - Bad Boy Hydrostatic Oil Recommended (Approximately 2.5 Quarts per side) 085-6000-00		



# SECTION 1: BASIC INFORMATION

Congratulations on the purchase of your new Bad Boy Mower! The purpose of this manual is to assist operators in maintaining and operating their mower. The information and instructions in this manual can help you in realizing many years of performance from your new Bad Boy. Also, check out our website to learn more about the Bad Boy family at [www.badboymowers.com](http://www.badboymowers.com).

## WARRANTY REGISTRATION

The Warranty Registration form must be completed within 30 days to validate your warranty. As the new equipment owner, you are expected to see that the registration form is completed by the selling dealer at time of delivery. **Warranty registration should be completed by the selling dealership using the on-line registration site.** Warranty is nontransferable.

## MODEL/SERIAL NUMBER

Your mower model and serial numbers are printed on a decal located underneath the seat. The entire alphanumeric code is your serial number, to find your model number, leave the last eight digits off of the serial number. When the time comes, these numbers are necessary for ordering parts.

## PARTS/SERVICE

Bad Boy recommends using Bad Boy replacement parts on your mower. Replacement parts are available through your local Bad Boy Mowers Dealer. Remember to have the following information close when ordering parts:

1. Part number
2. Serial number

All warranty repair and service must be handled through your authorized Bad Boy dealer. To locate the nearest dealer, go to the website listed above and click on "Locate a Dealer."



## SECTION 2: MOWER SAFETY GUIDELINES

Never allow untrained people to operate this mower. It is the owner's responsibility to get training and see to it that anyone who has permission to use your mower receives the proper training. Do not mow around people. The factory discharge chute is designed to deflect debris downward, but it could be possible for debris to be thrown in a way that can cause damage to people or property. Seek additional training when possible to learn more about safety techniques and practices. **This mower is capable of amputating hands and feet and throwing objects. Failure to observe the following safety instructions could result in serious injury or death.**

### GENERAL OPERATION

- 2.1 Read, understand, and follow all instructions on the mower and in the manual before starting.
- 2.2 Do not put hands or feet near rotating parts or under the mower. Keep clear of the discharge opening at all times.
- 2.3 Always remain seated while operating the mower. If the mower is equipped with Roll Over Protection Structure (ROPS), always buckle your seat belt.
- 2.4 Only allow responsible adults who are familiar with the instructions to operate this mower.
- 2.5 Clear the area of objects such as rocks, wire, toys etc., which could be thrown by the blades.
- 2.6 Always maintain a safe distance from people and pets just prior to and during operation. Stop the mower if anyone enters the area.
- 2.7 Never carry passengers.
- 2.8 Do not mow in reverse unless absolutely necessary. Always look down and behind before and while backing.
- 2.9 Never direct discharged material toward anyone. Avoid discharging material against a wall or obstruction as material may ricochet back toward the operator. Stop the blades when crossing gravel surfaces.
- 2.10 Never operate the mower without the discharge chute, grass catcher, or other safety devices correctly in place and functioning properly.
- 2.11 Slow down before turning.
- 2.12 Always disengage blades, place steering controls in neutral, engage parking brake, and remove ignition key when leaving operators seat. Never leave a running mower unattended. Disengage blades when not mowing.
- 2.13 Shut off engine, allow all moving parts to come to a complete stop, and allow to cool before performing any of the following actions: cleaning or inspecting the mower for damage, removing the grass catcher, or unclogging the discharge guard.
- 2.14 Always operate the mower in daylight or with adequate working lights.
- 2.15 Do not operate the mower while under the influence of alcohol or drugs.
- 2.16 Watch for traffic when operating near or crossing roadways.
- 2.17 Always wear eye protection when operating or servicing the mower.
- 2.18 Always wear ear protection, such as earplugs, while mowing.
- 2.19 Use extra care when loading or unloading the mower into a trailer or truck.
- 2.20 Be alert of surroundings. Watch for rocks, stumps, mounds, depressions, and low hanging limbs or objects that could be potentially hazardous while mowing.
- 2.21 Data indicates that operators 60 years of age and above are involved in a large percentage of riding mower related injuries. These operators should periodically evaluate their ability to operate the riding mower safely enough to protect themselves and others from serious injury.
- 2.22 Prevent fires by keeping deck, engine, and exhaust areas **clear of grass clippings and other debris**. Do not back or park the mower over, or immediately adjacent to, flammable materials.



## SETTING DECK HEIGHT

- 2.23 If your mower is equipped with an actuator motor, raise the deck using the raise /lower switch. Refer to section 7 (Controls). When the deck is raised, set the desired height with the deck height control dial, then lower deck with the raise / lower switch.
- 2.24 If your mower is equipped with a foot pedal, press foot pedal to raise the deck, select your desired deck height with the deck height dial, then slowly release foot pedal.

## SLOPE OPERATION

Slopes are a significant factor related to loss of control and tip-over accidents, which can result in severe injury or death. Operation on all slopes requires extra caution. If you cannot back up the slope, or you feel uneasy on it, do not mow it. Avoid operating your mower on hills of over 5° if mowing transverse to the slope, or on a slope of over 10° when driving uphill, or 15° when driving downhill.

- 2.25 Mow up and down slopes, not across.
- 2.26 Watch for holes, ruts, bumps, rocks, or other hidden objects that tall grass can obscure. Uneven terrain could overturn the mower.
- 2.27 Choose a low ground speed when operating the mower on a slope.
- 2.28 Do not mow on wet grass, the tires may lose traction.
- 2.29 Do not attempt to coast down a slope in the neutral position.
- 2.30 Avoid starting, stopping, or turning on a slope. If the tires lose traction, disengage the blades and proceed slowly, straight down the slope.
- 2.31 Keep all movement on slopes slow and gradual. Sudden changes in speed or direction could cause the mower to roll over.
- 2.32 Use extra care while operating the mower with grass catchers or other attachments: they can affect the stability of the mower. Do not use on steep slopes.
- 2.33 Do not try to stabilize the mower by putting your foot on the ground.
- 2.34 Do not mow near drop-offs, ditches, or embankments. The mower could suddenly and dangerously rollover if a tire goes over the edge of a drop-of. Drop-off edges can become extremely weak after rain while appearing deceptively sound.
- 2.35 Be aware of what is located at the bottom of slopes. For example, rocks water, cliffs, and roadways.

## CHILDREN

Tragic accidents can occur if the operator is not alert to the presence of children. Children are often attracted to the mower and the mowing activity. NEVER assume that children will remain where you last saw them.

- 2.36 Keep children out of the mowing area and in the watchful care of a responsible adult other than the operator.
- 2.37 Maintain Alertness and turn mower off if a child enters the area.
- 2.38 Before and while backing, look behind and down for small children.
- 2.39 Never carry children, even with blades shut off. They may fall off and be seriously injured or interfere with safe mower operation. Children who have been given rides in the past may suddenly appear in the mowing area for another ride and be run over or backed over by the mower.
- 2.40 Never allow children to operate the mower.
- 2.41 Never leave the key in the ignition, especially around children.
- 2.42 Use extreme care when approaching blind corners, shrubs, trees, or other objects that may block your view of a child



## TOWING

Max. pulling weight: 500 lbs.

Max. at 5°: 440 lbs.

Max tongue weights: 61" = 80 lbs.

- 2.43 Tow only with a mower that has a hitch specifically designed for towing. Do not attach towed equipment except at the hitch point.
- 2.44 Follow towing recommendations provided.
- 2.45 Never allow children or others in, on, or around towed equipment.
- 2.46 On slopes, the weight of the towed equipment may cause loss of traction or instability.
- 2.47 Travel slowly and allow extra distance to stop.

## SERVICE

### SAFE HANDLING OF FUEL

To avoid personal injury or property damage, use extreme care in handling gasoline. Gasoline is extremely flammable, and the vapors are explosive.

- 2.48 Extinguish all cigarettes, cigars, pipes, and all other sources of ignition.
- 2.49 Use only an approved gasoline container.
- 2.50 Never remove gas cap or add fuel with the engine running.
- 2.51 Allow engine to **cool for a minimum of 5 minutes** (longer on exceptionally hot days, >95F) before refueling.
- 2.52 Never fuel the mower indoors.
- 2.53 Do not store the mower near open flame or source of ignition, such as a water heater or furnace.
- 2.54 Remove equipment from the truck or trailer and refuel it on the ground. If this is not possible, then refuel such equipment with a portable container, rather than from a fuel dispenser nozzle.
- 2.55 Never fill fuel containers inside a vehicle or on a truck or trailer bed with a plastic liner. Always place containers on the ground away from your vehicle before filling.
- 2.56 Keep the nozzle in contact with the rim of the fuel tank or container opening at all times until the fueling is complete. Do not use a nozzle lock-open device.
- 2.57 If fuel is spilled on clothing, change clothing immediately.
- 2.58 **Never overfill fuel tank.** The fuel tank is full when the fuel level reaches the bottom of the fill tube. Do not over-fill. Overfilling can reduce the effectiveness of fuel tank safety mechanisms.

### GENERAL SERVICE

- 2.59 Never operate the mower in a closed area where dangerous carbon monoxide fumes can collect.
- 2.60 Keep all nuts and bolts tight to be sure the equipment is in safe working condition. Never operate a poorly maintained mower.
- 2.61 Do not touch hot areas of the mower.
- 2.62 Never interfere with the intended function of a safety device or reduce the protection provided by a safety device. Check their proper operation regularly.
- 2.63 Keep the entire mower free of grass, leaves, or other debris build up. Clean up oil or fuel spillage and remove any fuel-soaked debris. Failure to do so can affect the safety and functionality of the mower, as well as increase the danger of a fire due to contact with the hot surfaces of the mower.
- 2.64 Allow mower to cool before storing.
- 2.65 If you strike something with the mower, turn the mower and blades off, engage the parking brake, and inspect the mower for damage. Repair, if necessary, before resuming.



- 2.66 Never make any adjustments or repairs with the engine running.
- 2.67 Check grass catcher components and the discharge guard frequently and replace with manufacturer's recommended parts, when necessary.
- 2.68 Mower blades are sharp. Wrap the blade or wear gloves before servicing them.
- 2.69 Check parking brake operation frequently. Adjust and service as required.
- 2.70 Maintain or replace safety and instruction labels, as necessary.
- 2.71 Do not attempt to mount a tire without the proper equipment and experience to perform the job.
- 2.72 Always maintain the correct tire pressure. Do not inflate the tires above the recommended pressure. Never weld or heat a wheel and tire assembly. The heat can cause an increase in air pressure resulting in a tire explosion. Welding can structurally weaken or deform the wheel.
- 2.73 Park the mower on level ground. Never allow untrained personnel to service the mower. Understand service procedures before doing work.
- 2.74 Mower deck, frame, and engine compartment should remain free of debris to prevent premature part failures or fire hazards.

## **SAFETY INTERLOCK SYSTEM**

Your Bad Boy mower is equipped with a safety interlock system. This system is designed to prevent property damage and severe injury or death to the operator and bystanders. These interlocks are essential and must be tested before each use. To test the interlock system, follow the steps below. **Note: unless otherwise noted, the operator must be seated properly on the mower during these tests. Additionally, the mower should be at operating temperature during this test.**

- 2.75 With the parking brake engaged, bring the lever arms to their inward position. Attempt to start the mower with the PTO switch in the OFF position. The engine should not start. Continue test.
- 2.76 On a level surface, disengage the parking brake and place lever arms to their outward position. Attempt to start the mower with the PTO switch in the OFF position. The engine should not start. Continue test.
- 2.77 Engage the parking brake and leave the lever arms in their outward position. Put PTO switch in the ON position. Again, attempt to start the mower; the engine should not start. Continue test.
- 2.78 Start the engine, as stated in the Mower Operation Section. Disengage the parking brake and very slowly begin to rise from the seat. The engine should stop. If the seat has been relieved of body weight and the engine has not stopped, there is a fault within the interlock system. End test.

If the safety interlock system does not operate as described above, an Authorized Service Dealer must repair this safety system immediately. The mower is unsafe to operate in this condition.

## **ROLL OVER PROTECTION STRUCTURES (ROPS)**

This mower is equipped with ROPS from the factory. It is vital that the rules below are adhered to. ROPS, when used correctly, dramatically decrease the fatality rate in roll-over instances.

- 2.79 Periodically ensure the bolts that attach the ROPS to the mower are securely fastened.
- 2.80 Always operate the mower with the ROPS secured in the upright position.
- 2.81 If the surrounding environment (e.g. low-lying limbs, signage, etc.) makes it impossible to mow with the ROPS upright, lower the ROPS at the hinge point, mow the area, then immediately secure the ROPS upright.
- 2.82 Upright ROPS are taller than the operator's head. Be aware of this and your surrounding environment, as referenced above. The mower and operator may clear low lying items, but the ROPS may not.
- 2.83 Always wear the provided seat belt when ROPS are utilized. Failure to use the seat belt severely handicaps the safety benefits of the ROPS.
- 2.84 In the event of a roll-over, replace the ROPS before resuming use of the mower.





## **SECTION 3: MOWER OPERATION**

***Never operate the mower with faulty equipment. Always be alert of sudden changes in landscape, as the mower will react differently on slopes or embankments than it will on flat surfaces. Never operate the mower with the discharge chute open. Do not cross terrain, other than grass, with blades turning as this could cause damage to property or bystanders.***

- 3.1 Owners must become familiar with the controls before operating a zero-turn radius vehicle. Start slowly and build your skill level. Have ample practice before using the mower at full capabilities.
- 3.2 Make sure nothing is under or around the mower.
- 3.3 Place the parking brake in the up position.
- 3.4 Drive arms must be in the "open" position. While sitting on the mower, each arm is positioned away from the operator, to the left and right. Drive arms will lock into place and must be in this position to start the mower.
- 3.5 Put PTO switch in the OFF position.
- 3.6 If your mower has been equipped with a ROPS (Roll Over Protection System) then you must fasten the seatbelt.
- 3.7 Engage the choke if the mower has not been started recently.
- 3.8 Position the throttle control between half and full throttle.
- 3.9 Place the key in the ignition. Turn the key to start the mower.
- 3.10 Once the mower is started, disengage the choke.
- 3.11 Increase RPM by sliding the throttle control to fast position.
- 3.12 Always engage PTO at full throttle.
- 3.13 Your mower will perform differently on an incline /decline. Be cautious, slow down, and do not make any sudden jerking movements with control arms. The mower could lose traction on a decline or tip backwards on an incline.
- 3.14 Once you become comfortable with your Bad Boy Mower you will notice your overall mowing time will decrease.

***Avoid operating your mower on side hills of over 5 degrees,  
inclines of over 10 degrees,  
and declines of over 15 degrees.***



BAD BOY MOWERS

# SECTION 4: MOWER MAINTENANCE

Maintenance	Interval					Section
	Daily	First 8 Hours	Every 50 Hours or Annually*	Every 100 Hours or Annually*	Every 250 Hours	
Check and add engine oil	●					Section 3
Check all belts for proper alignment	●					Section 2 (Pump) 6 (Deck)
Check tire pressure and wheel lug nuts	●					Section 5
Check battery terminal connections	●					Section 4
Check condition of blades	●					Section 6
Check for fuel and oil leakage	●					Section 3
Check deck and engine compartment for debris and clean as necessary	●					
Check air filters	●					
Initial oil change		●				Section 3
Tighten nuts and screws			●			
Change engine oil and filter			●			Section 3
Initial change of hydraulic oil and filter			●			Section 1
Grease mower				●		Section 5
Replace air element and pre-cleaner <sup>♦</sup>				●		Section 3
Replace fuel filter <sup>♦</sup>				●		Section 3
Clean or replace spark plugs and set gap				●		Section 3
Change hydraulic oil and filter					●	Section 1
Clean combustion chamber <sup>Dealer</sup>					●	
Check and adjust valve clearance <sup>Dealer</sup>					●	
Clean and lap valve seating surface <sup>Dealer</sup>					●	

\*Maintenance by hour or annually whichever comes first

<sup>♦</sup>Check air and fuel filter more often in dusty conditions

<sup>Dealer</sup>Get maintenance performed at a registered dealership

# SECTION 5: MOWER STORAGE & TRANSPORTATION

- 5.1 Keep the mower from collecting debris by storing in a covered area while not in use.
- 5.2 Disconnect the negative battery cable when the mower will be stored for more than 30 days.
- 5.3 Always secure the mower properly when transporting.
- 5.4 Do not load the mower on a trailer while the blades are engaged.
- 5.5 Do not use ramps to load the mower.
- 5.6 Make sure Parking Brake is in the engaged position.
- 5.7 In wet conditions, tires may spin during loading/unloading. If necessary, wait for dry conditions before loading/unloading.
- 5.8 Make sure the mode of transportation is suitable to bear the weight of the mower.
- 5.9 Deck height should be set at maximum before attempting to load.
- 5.10 Secure mower with at least two straps capable of securing the weight of the mower.
- 5.11 Always ensure the mower engine and exhaust have cooled before parking inside an enclosure.



## SECTION 6: FAQ

6.1 **Q: *How do I prevent an uneven cutting pattern and increase the quality of cut?***

**A:** Check tire pressure, check blade sharpness (replace blades or sharpen at least once per year or when needed), make sure blades are tightened properly, check spring and belt tension, check the underside of the deck to ensure the mower deck is free of grass build-up and debris, make sure your mower is at full throttle, and vary your mowing pattern each time you cut your grass.

6.2 **Q: *What should I do if my mower won't start?***

**A:** Check battery charge and connection (grounds), check your fuel (make sure fuel is less than 30 days old and contains no water), make sure your spark plug is in good condition and spark plug wire is attached, make sure air filter is clean (a dirty filter makes it more difficult for the engine to draw air), check the integrity of the 25-amp main fuse, and check for any bare wires and/or bad connections.

6.3 **Q: *What should I do if the blades won't engage?***

**A:** Make sure the safety switch is plugged in on the bottom of the seat. Check the underside of the blade power switch to ensure the plug is secure at the switch. Also, check PTO fuse underneath operator console (10-amps).

6.4 **Q: *Are my blade bolts right-handed thread?***

**A:** Yes. These bolts require counter-clockwise rotation to remove.

## FUEL

We recommend that a quality fuel is used for optimum performance. Refer to engine manual for recommended fuel to use. Ultra-Low Sulphur Diesel (ULSD) fuel is required for all Tier 4 diesel engines.

## CLEANING YOUR MOWER

It is recommended that you use an air hose or blower to remove dust and debris from the mower, to ensure there is not a buildup of grass on the mower deck and engine compartment, which could become a fire hazard. If you must wash the mower, ensure you run the engine to operating temp to dry water and engage the blades to spin off any standing water on the pulleys. Avoid spraying water onto electrical components and bearings, to prevent premature failure of these parts.



BAD BOY MOWERS

## SECTION 7: CONTROLS

- 7.1 **Ignition Switch:** Bad Boy mowers have a three-position ignition switch: off, run, and start. With key inserted, rotate it clockwise to START position and release key when engine starts, and switch will automatically return to the RUN position.
- 7.2 **Throttle Control:** A cable is connected to the engine throttle for controlling engine speed. Move lever forward to increase engine rpm, move lever backward to decrease engine rpm.
- 7.3 **Pre-Heat Button:** This mower is equipped with a glow plug pre-heater. To activate turn ignition to the ON position and hold button for five seconds before starting the engine.
- 7.4 **Control Levers:** These levers control the mower's speed, direction, and neutral lock. These levers are used to steer, accelerate, decelerate and change direction.
- 7.5 **Blade Engage Switch:** This switch engages the blades. Pull the switch up to engage the blades and push the switch down to disengage the blades.
- 7.6 **Parking Brake:** This lever engages the parking brake. Pull back fully to engage the parking brake; push forward to disengage.
- 7.7 **USB Charging Port:** Your mower is equipped with a USB charging port for your accessory needs.
- 7.8 **Deck Height Control:** The deck height dial is used to set the cut of the deck.
- 7.9 **Deck Travel Lock:** The deck travel lock holds the deck in a transport position.

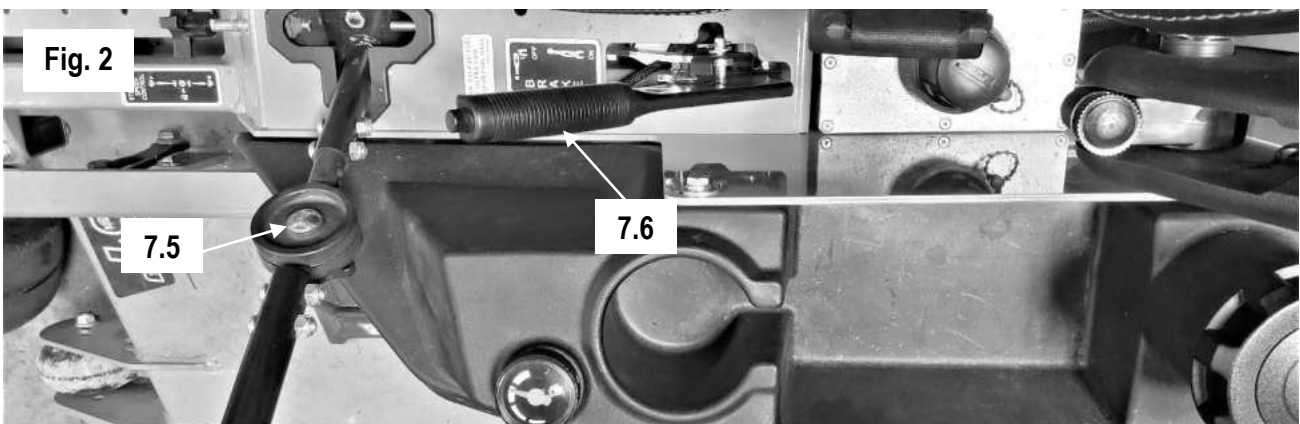
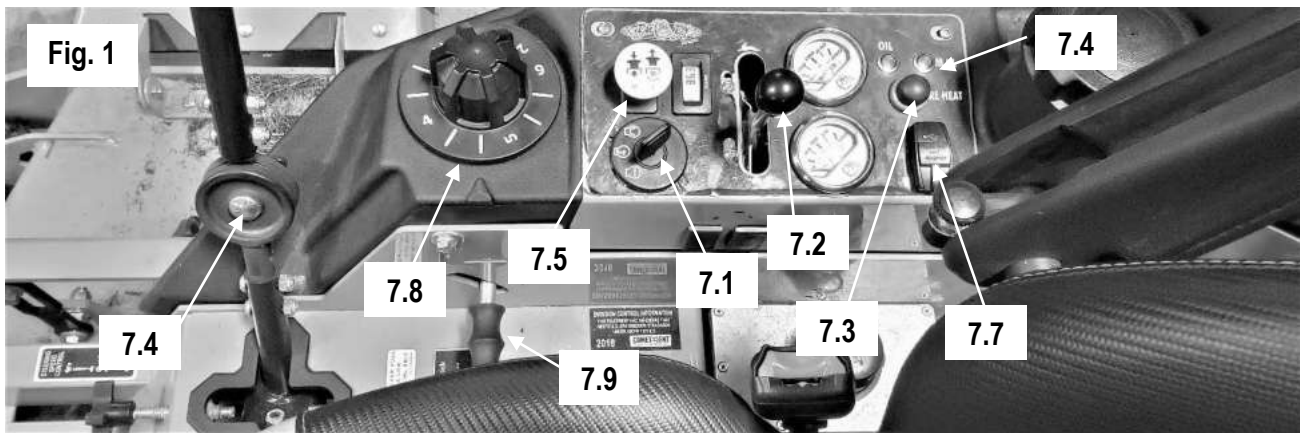



BAD BOY MOWERS

## SECTION 8: INSTRUMENTATION

- 8.1 **Coolant Temperature Gauge:** The Renegade diesel is equipped with a coolant temperature gauge for monitoring engine temperature.
- 8.2 **Oil Pressure Gauge:** The Renegade diesel is equipped with an oil pressure gauge for monitoring engine oil pressure.
- 8.3 **Electronic Hour Meter:** Registers hour increments up to 9,999.9 total hours. This meter records the cumulative time the engine is running.
- 8.4 **Oil Light:** Alerts the operator that there is a low oil pressure situation inside the engine.
- 8.5 **Malfunction Indicator Light:** Alerts the operator that the ECM has detected an issue with the engine.

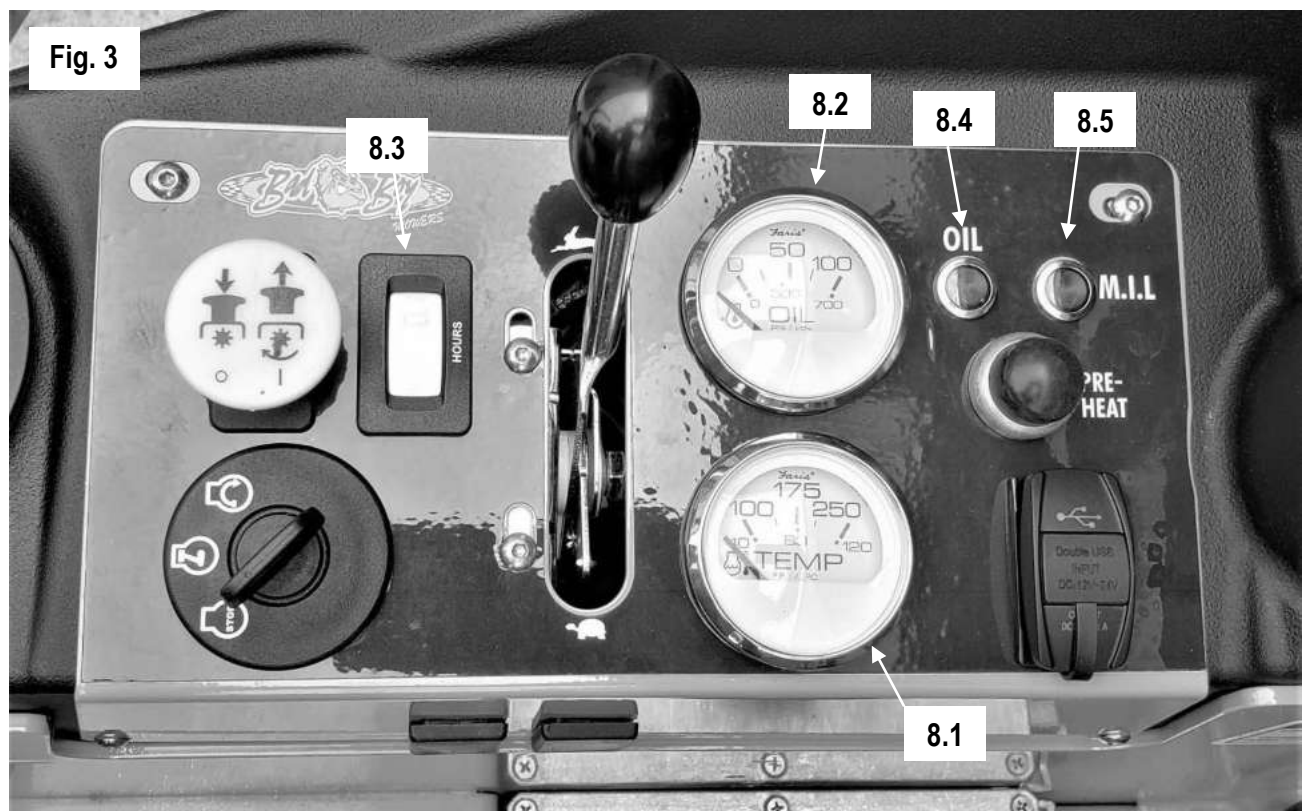



BAD BOY MOWERS

## SECTION 9: MOVING INOPERABLE MOWER

- 9.1 Hopefully, you'll never need to use this section of the manual. However, if you do, use extreme caution when moving the mower! You should never try to push or pull the mower by hand. This could cause serious bodily injury.
- 9.2 Do not tow the mower. Use a winch to load on a trailer for transporting.

Your Mower Weighs: **RENEGADE SERIES 1790 lbs.**

*\*\*\*Weights fluctuate with the addition of accessories.*

- 9.3 If it becomes necessary to move an inoperable mower, the drive pumps are equipped with bypass valves that allow the drive tires to rotate freely. These bypass valves are located at the rear of the pumps. Each require to loosen a 1/2 to a full turn to allow for proper bypass.

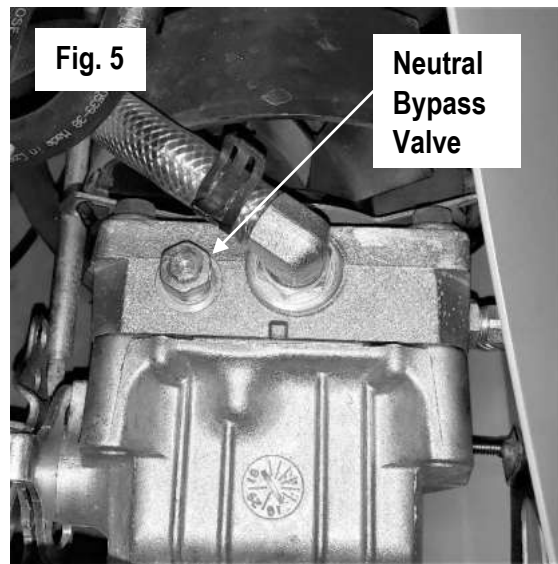
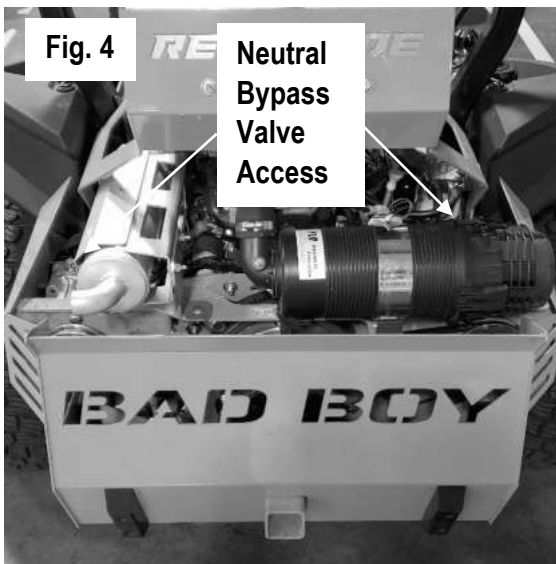



---

## **SECTION 10: MOWER BLADE MAINTENANCE**

***(REMEMBER: NEVER CHECK BLADES WHILE ENGINE IS ON!  
NEVER CHECK BLADES WHILE BLADES ARE ENGAGED!)***

- 10.1 Check mower blades after each use. This is essential for maintaining well-groomed turf. Keep the blades sharp. If a dull blade is used for cutting, the grass will tear rather than cut. This could damage the grass leaving a brown frayed top on the grass within a few hours. A dull blade will also require more power from the engine.
- 10.2 NEVER attempt to straighten a bent blade by heating. NEVER attempt to weld a cracked blade. The blades can break and cause serious injury or death.
- 10.3 NEVER work with blades while engine is running or PTO clutch is engaged.
- 10.4 ALWAYS place PTO clutch in DISENGAGE position while performing maintenance.
- 10.5 Use approved lifting equipment when working underneath your mower.
- 10.6 ALWAYS wear thick gloves when handling blades.
- 10.7 ALWAYS check for blade damage if mower strikes rock, branch, or other objects that could potentially damage the blade.

## **SECTION 11: EQUIPMENT LUBRICATION**

- 11.1 Park the mower on a level surface and disengage the blade control switch.
- 11.2 Move the motion control levers outward to the neutral position, engage parking brake, stop the engine, remove the key, and wait for all moving parts to stop before leaving the operating position.
- 11.3 Grease Type: NLGI grade #2 multi-purpose gun grease.
- 11.4 Clean the grease fittings with a cloth. Scrape any paint off the front face of the fitting(s).
- 11.5 Connect a grease gun to each fitting. Pump grease into the fitting until grease seepage is observed. Be mindful of over-pressurization. Do not force the grease into the component if excessive back pressure is felt as this can lead to reduced life of the component(s). Wipe up excess grease.
- 11.6 Refer to service manual section for grease fitting locations.



# HOW TO CHOOSE THE RIGHT BLADE

Essentially there are only TWO basic styles of mowing blades used or approved for use on our current products:

1. The standard style of mowing blade is essentially designed for cutting grass and effectively discharging the clippings out from the deck to fall onto the lawn or to be captured in a grass collection system. Standard blades are also referred to as “2-in-1” (discharging & bagging) or “high-lift” blades (because they are designed to create a higher-lifting airflow).
2. Mulching blades generally have a more curved style surface and frequently include extra cutting surfaces along the blade edges. These blades may also come in a “+” design (which is actually two individual blades arranged in a perpendicular fashion to enhance mulching). The “+” blades are usually found on older style mowers; newer ones utilize blades with more advanced mulching technology. Mulching blades may also be referred to as “3-in-1” (mulching, discharging & bagging) or “all-purpose” blades.

Bear in mind that the re-circulating airflow design of 3/1 blades makes them less efficient at discharging grass clippings than a standard 2/1 blade. As with most all-purpose tools, there is some give and take as opposed to using a tool designed for a more specific purpose.

If you’re experiencing less-than-desired cutting or discharging performance with a 3/1 blade, you may want to check into using a 2/1 blade. Conversely, if you’re using a 2/1 blade and want to mulch clippings, you should see about the availability of mulching blades or a mulching kit. \*

The type of blade installed on a new mower is a decision the retailer makes for each model of mower, based on the expected needs of most customers. If you’re unsure of which blade is on a particular model, inspect the blade. Blades have part numbers stamped into them. Then compare these part numbers with the unit’s Operator’s Manual or Parts List.

It is true there are many other styles of blades available. But since we don’t manufacture or recommend using these other aftermarket styles, we will leave them out of this discussion. Should you want more information on special application or aftermarket blades, you should contact the companies that make these products. NOTE: Customers using non-OEM blades do so at their own risk. The use of unapproved (non-OEM) blades may void any or all of the mower and engine factory warranties.

\* **MULCHING KITS** – These generally consist of mulching blades and a mulching plug (which closes off the discharge opening to keep the clippings contained under the deck for re-cutting) plus any necessary hardware for installation. Please check with your parts distributor regarding the contents of a particular mulching kit.





## MOWING TIPS:

- Mow header strips at the ends of the lawn and around flower beds first. Make them wide enough that you can turn the mower around in the already mown section. Then mow back and forth between these header strips overlapping each lap by about 1/8 the width of the mower's deck.
- Don't cut your grass too short, particular for cool season grasses. Higher heights usually provide for a deeper root system, looks better, and is less likely to have weeds invading, particularly crabgrass.
- Don't remove any more than one third of the grass leaf at any one cutting. If circumstances arise that a lawn gets too tall and you just have to lop off a bunch to get caught up, bite the bullet and break it down into several mowings to get caught up with 3 or so days between cuttings.
- NEVER SCALP YOUR LAWN.** Scalping severely damages the root system to such a degree that it may die.
- Avoid mowing when the grass is wet or when it's dark
- Avoid throwing grass clippings into the street and driveway where they can be washed into the sewer system. After mowing, clean up driveway and walkways.
- When mowing remove only a third with each cutting (except for the first mowing of the season when it's ok to remove more). You can safely leave clippings that will quickly decompose and add nutrients back into the soil. Contrary to popular opinion, grass clippings do not add to thatch buildup. Grass blades are made up of about 75% water.
- Mow your lawn in a different direction with each mowing, especially with lawns of shorter grass types. Altering the direction ensures a more even cut since grass blades will grow more erect and less likely to develop into a set pattern.
- Keep your mower's blade sharp, which means having it sharpened several times during the mowing season. Keep several blades around so you'll always have a sharp one on hand. Sharp blades cut the grass cleanly and help mulch clippings into small pieces which break down quickly.
- Don't forget to change your mower's oil at least once during the mowing season. For brand new mowers, change the oil after about 5 hours of operation during the initial break-in period.
- At the end of the mowing season use a fuel stabilizer in the remaining gasoline
- In the spring, don't use that old gas unless you properly used a fuel stabilizer, it can cause a number of problems. Better to use fresh gasoline to begin the new mowing season.
- Leaf blade A** demonstrates what a leaf blade should look like after mowing with a sharp blade.
- Leaf blade B** demonstrates a leaf blade that was injured by a dull mower blade.
- Leaf blade C** was cut by the mower but indicates that the mower blade is not sharp enough. The shredded white tissue protruding from the leaf blades C and D is the vascular tissue of the plant.
- Leaf blade D** has been mown for quite some time with a dull mower blade.

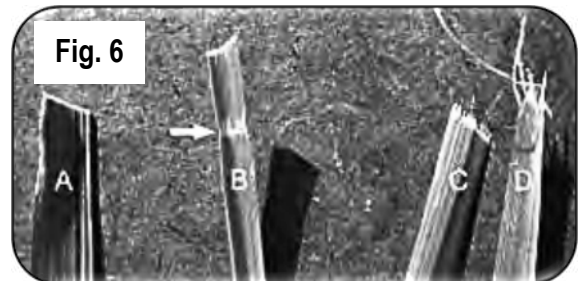

## TO BAG OR TO MULCH?

Grass clippings do not contribute to thatch buildup or increase the chances of disease. If you mow your lawn at the right height, without removing any more than 1/3 of its total height, clippings will quickly breakdown without a trace. These clippings contribute additional nitrogen and other nutrients to the soil and supply it with additional organic materials. Clippings from a 1000 sq. ft. lawn can add as much as 1 - 2 pounds of nitrogen back into the soil. If you have a compost pile, then you may want to bag your clippings occasionally to add much needed green-matter to the compost pile. Make sure it is mixed thoroughly with brown matter to avoid a strong ammonia odor. **DO NOT COMPOST CLIPPINGS** after applying any weed control or weed-feed type product. Before adding clippings to the compost pile wait at least 3 mowings after these products have been applied.

# SERVICE SECTION

## SECTION 12: HYDROSTATIC SYSTEM

The hydro reservoir tank on the Outlaw Renegade model is located just behind the seat, on each side of the frame. There is a sight tube on the rear of the tank that indicates the current hydraulic oil level. The oil level should be filled until the level reaches the bottom of the upper fitting. Do not overfill. If an air bubble is present in the tube, add oil until the level reaches the fitting and the air bubble is no longer visible. Use only 20W-50 motor oil in this tank. Conventional or synthetic oil may be used. Bad Boy Hydrostatic Oil is recommended. Bad Boy recommends that the hydraulic oil and filters be changed within the first 50 hours of use; then at intervals of 250 usage hours. It is also recommended to use Bad Boy replacement filters. Use of any filter not designed for this application could result in damage of the hydraulic system and void the warranty. Each side requires approximately two quarts of oil to refill the system.

**THE FOLLOWING MAINTENANCE IS TO BE PERFORMED ON A LEVEL SURFACE.**

### CHANGING YOUR HYDRAULIC OIL AND FILTER

1. Place an oil drain pan (12" or more in diameter and 8 qt. capacity is optimal) beneath the oil filter. Remove the oil filter from the oil reservoir to drain the oil.
2. After the oil has drained from the reservoir, install new oil filter. Tighten  $\frac{3}{4}$  turn past gasket contact.
3. Fill the reservoir with new 20W-50 motor oil through the fill cap. The oil level should be filled until the level reaches the bottom of the upper fitting. Do not overfill. If an air bubble is present in the tube, add oil until the level reaches the fitting and the air bubble is no longer visible.
4. Drain the old oil filter of all free-flowing oil prior to disposal. Place used oil in appropriate containers and deliver to an approved recycling collection facility.
5. Proceed to the purge procedure.

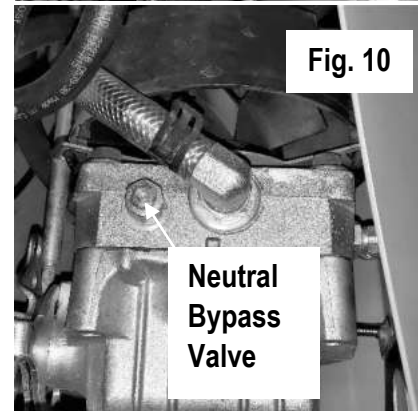
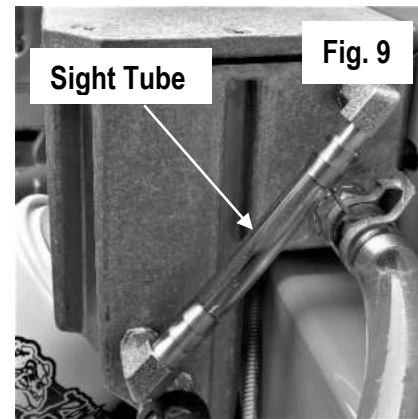
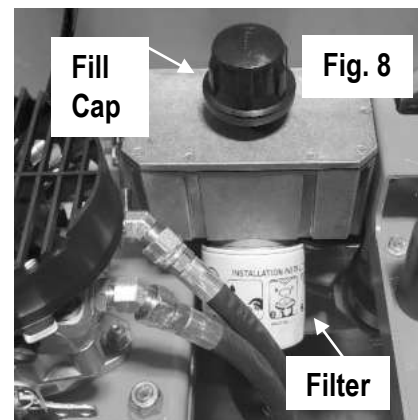
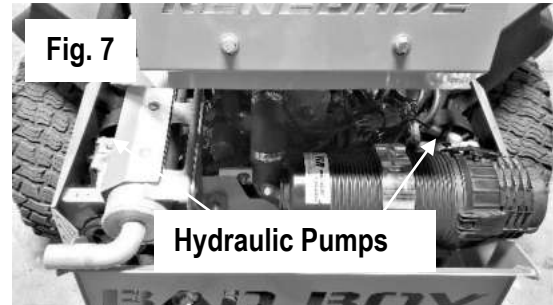

## PURGING PROCEDURE

Due to the effects air has on the efficiency in hydrostatic drive applications, it is critical that the air is purged from the system. These purge procedures should be implemented any time a hydrostatic system has been opened to facilitate maintenance or any additional oil has been added to the system.

1. Lift the rear tires of the mower off of the ground and chock your front tires so they do not move.
2. With the bypass valve open (To open bypass valve, loosen  $\frac{1}{2}$  to 1 full turn) and the engine running, slowly move the directional drive arms in the forward and reverse directions (5 to 6 times), as air is purged from the unit, the oil level will drop.
3. With the bypass valve closed and the engine running, slowly move the directional drive arms in the forward and reverse directions (5 to 6 times). Caution: the tires will rotate during this procedure. Turn off engine. Check the oil level, and add oil as required after stopping the engine.
4. It may be necessary to repeat steps 1 through 3 until all the air is completely purged from the system. When the tires move forward and reverse at normal speed purging is complete.

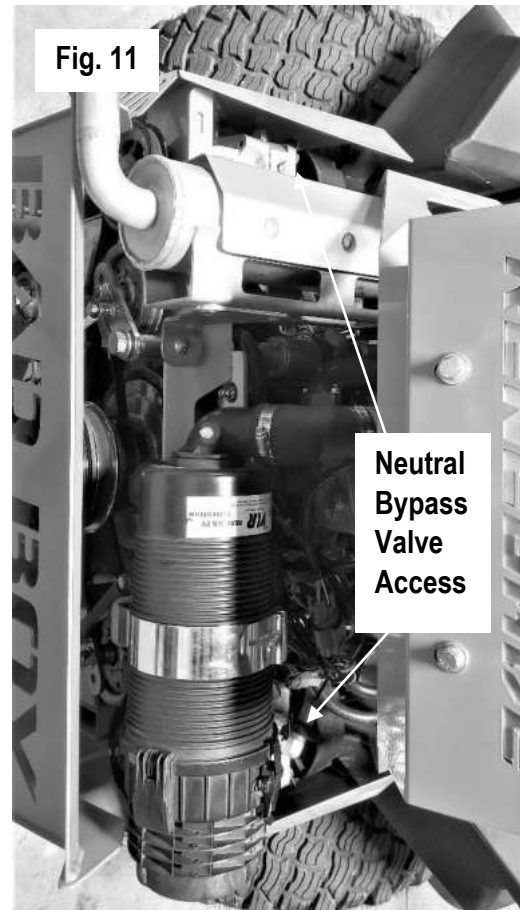

To adjust the tracking on the mower, lengthen or shorten the push rods shown in Fig. 12. Lengthening the push rod will increase the speed of the pump. Shortening the push rod will decrease the speed of the pump. Typically tracking adjustments should be made to the faster side first. Fine tuning adjustments can be made by turning the adjustment knob, Fig. 13, in front of either steering arm until the desired effect is achieved.

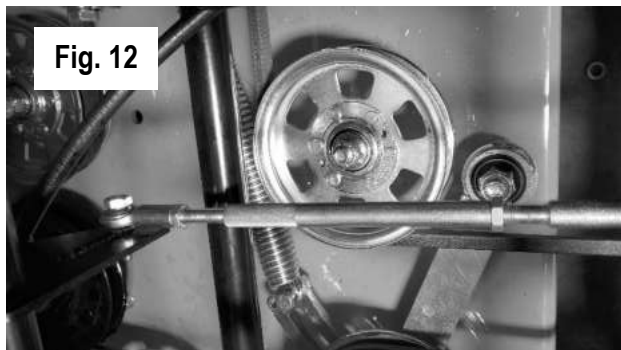



## SECTION 13: DRIVE BELT

To access the rear of the pump plate, loosen the nuts holding the rear cover in place 1 ½ turns using a 9/16 wrench. Once loosened slide the rear cover rearward until it stops. Then the rear cover will pivot down giving access to the pump belts, clutch, and oil filter.



The Renegade drive belt utilizes a two-belt system with auto adjusting tensioners. The use of a 3/8 ratchet and short extension may be required for installation or removal of a drive belt.

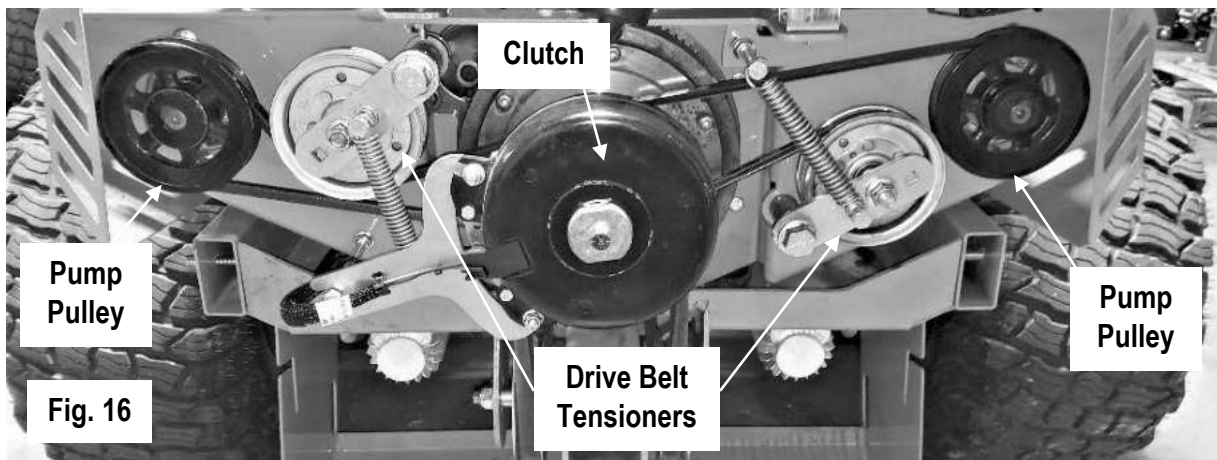
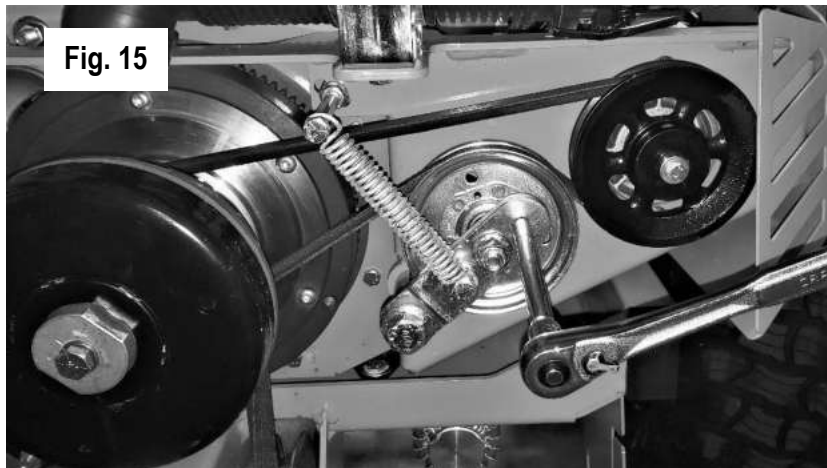

## SECTION 14: ENGINE

Perkins Model: 403F-11

Reference section 4 for the oil change interval and the engine's service manual for oil quantity. Bad Boy 15W-40 engine oil is recommended for maximum protection.

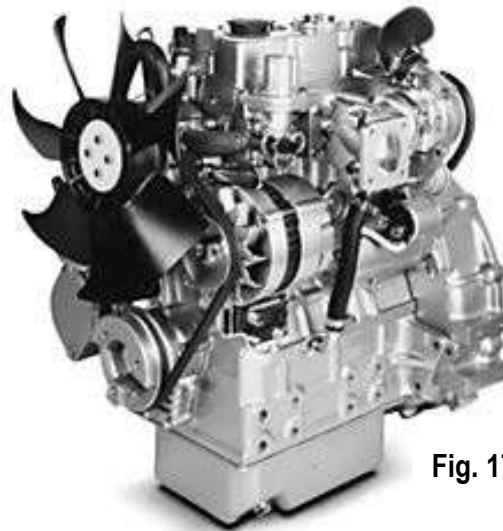

Fig. 17

### CHANGING YOUR ENGINE OIL AND OIL FILTER

1. Place an oil drain pan (12" or more in diameter and 8 qt. capacity is optimal) beneath the oil drain plug. Remove oil drain plug and allow oil to drain completely.
2. The oil filter is located on the right side of the engine block. Clean area around oil filter. Remove oil filter and clean sealing surface. Lubricate oil filter seal. Install new oil filter and tighten  $\frac{3}{4}$  turn past gasket contact.
3. Fill crankcase with approximately 3.25 quarts of new oil. Level should reach top of indicator on dipstick.
4. Start engine; check for oil leaks. Stop Engine; correct oil leaks if present. Recheck oil level.
5. Dispose of used oil and filter in accordance with local ordinances.

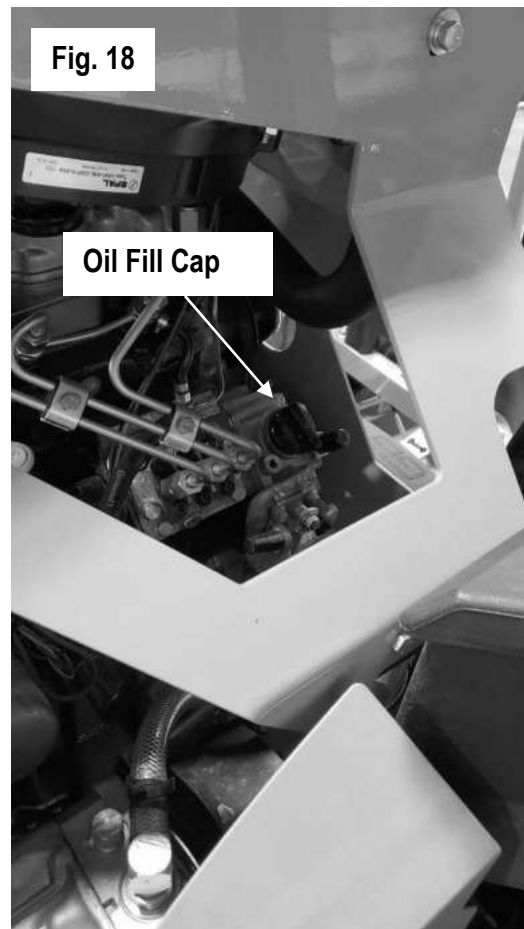

Fig. 18

Oil Fill Cap

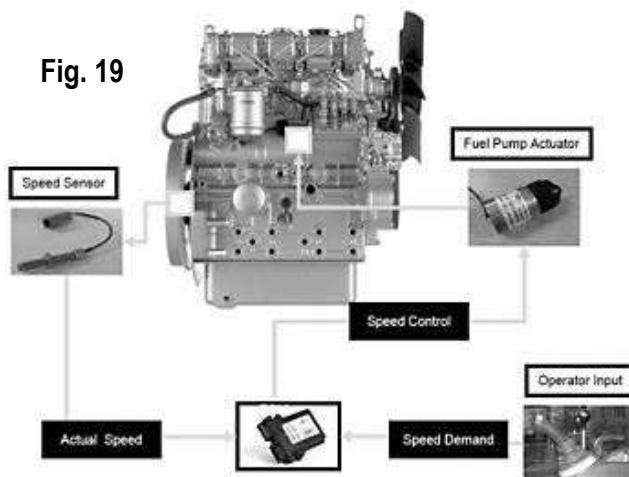

Fig. 19

## Fuel System

When servicing the fuel system on the Diesel, it is necessary to purge the air from the system by loosening the 9/16" bolt on top of the fuel filter and turn the ignition to the ON position. This will activate the electric fuel pump. Tighten 9/16 bolt after air bubbles are no longer visible. Turn ignition to OFF.

### CHANGING YOUR FUEL FILTER

1. Your 1100cc Diesel has two fuel system filters. The first is a filter/water separator.
2. Open the drain on the bottom of the fuel/water separator. Catch the draining fluid in a suitable container. Dispose of the drained fluid correctly.
3. Close drain.
4. The second fuel filter is a canister located above the fuel/water separator.
5. Close the fuel supply valve.
6. Clean the outside of the fuel filter assembly.
7. Remove the filter housing bolt from the bottom of the filter.
8. Remove the canister. Ensure that any fluid is drained into a suitable container.
9. Assemble the following items: seals (8), seal (7), canister (3), and bowl (10). Place washer (5) and seal (6) on setscrew (2).
10. Fasten the assembly to the fuel filter base with housing bolt (2).
11. The fuel system will need to be primed after the new filter is installed. Refer to air purging instructions at top of page.

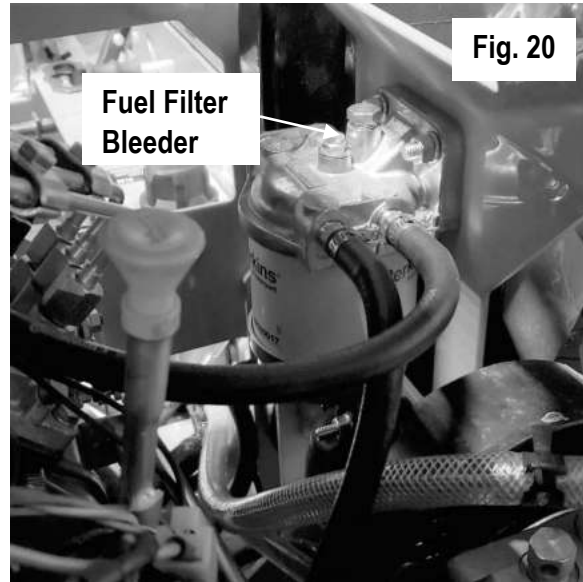

Fig. 20

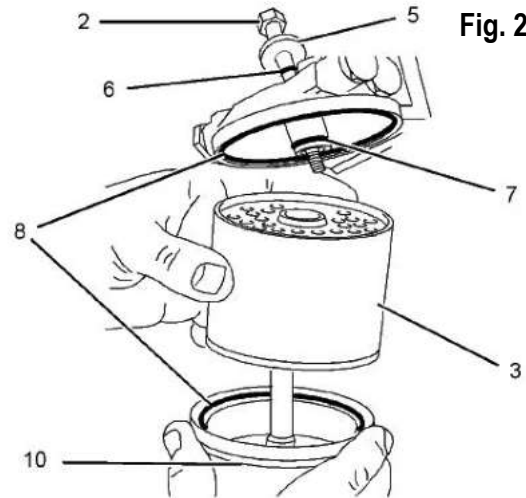

Fig. 21

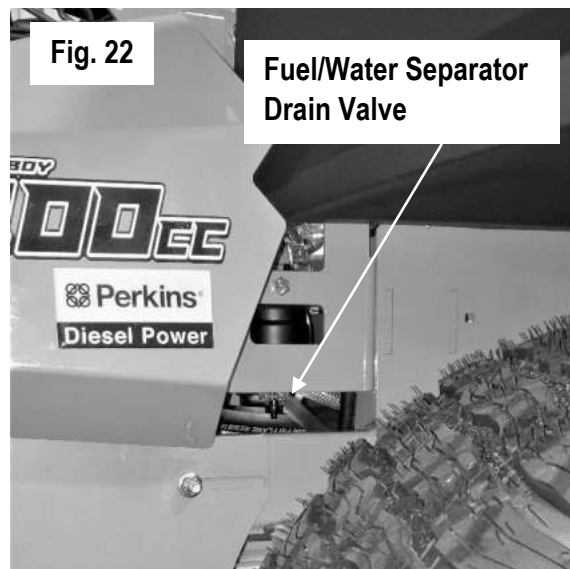

Fig. 22

Fuel/Water Separator Drain Valve

## Air Cleaner

The air cleaner is the engine's only defense against damaging foreign particles. It is very important that the air cleaner element is inspected prior to each use. Remove the element and tap its sides in order to remove debris. Do not blow the filter out using compressed air. Doing so will greatly reduce the air cleaner's effectiveness. Replace yearly; more often in dusty environments. Adhering to these practices will help prevent loss of power and premature engine failure.

### CHANGING THE AIR CLEANER

1. Locate the air filter and unbuckle all of the air filter cover latches.
2. Remove the cover and take out the outer element and the inner element.
3. Clean or replace elements.
4. Reattach the cover.

## Radiator Debris Screen

The radiator is equipped with a removable screen that must remain free of debris at all times to ensure proper engine cooling. Check screen hourly during dry conditions.

### Cleaning the Radiator Debris Screen

1. Allow radiator to cool.
2. Remove thumb screws and screen hold down bracket.
3. Slide screen back and up.
4. Clean screen thoroughly of all debris using high pressure air or water as necessary.
5. Reinstall in reverse order.

## Coolant Expansion Tank

This mower is equipped with a coolant expansion tank. The proper coolant level is at the "L" mark when the coolant is cold and at the "H" mark when the engine is at operating temperature. Check coolant level before mower operation.

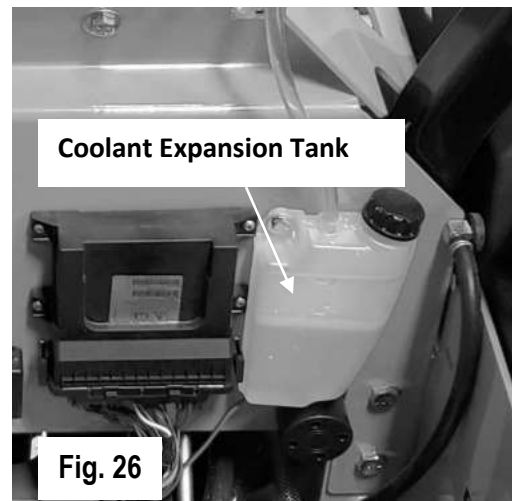
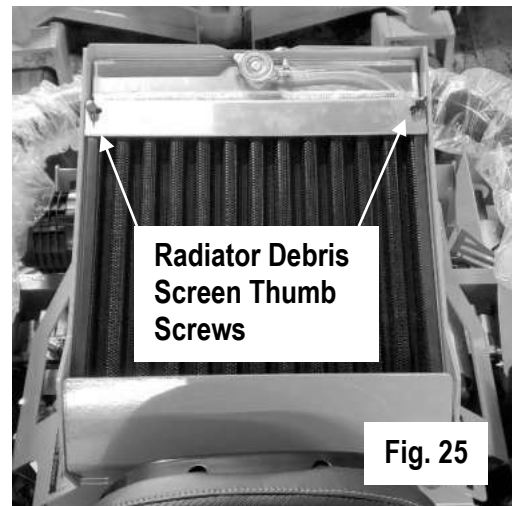
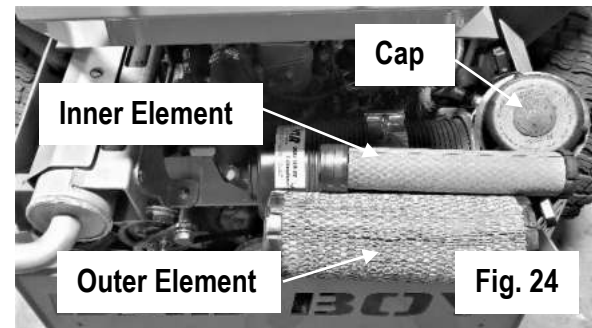
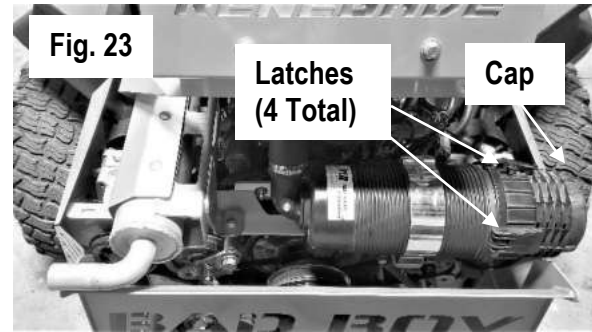



BAD BOY MOWERS

## SECTION 15: ELECTRICAL SYSTEM

This mower is equipped with multiple protective fuses. Ensure all fuses are clean and well connected.

A blown fuse usually indicates a problem within the electrical system or an electrical component. Ensure the battery terminals are tightly fastened. Never replace a fuse with one of a higher amperage rating or 'bypass' a fuse in any way. Doing so creates a significant fire hazard and can cause severe damage to the mower's electrical components. If a fuse is repeatedly blowing, contact your Bad Boy dealer.

Check the condition and connection of the relays. Ensure that they are clean and connected. Make sure that wire terminal ends have not been pushed out of the relay block.

To check for proper charging (13.6 - 14.2 volts DC), take a voltage reading across battery terminals with engine at full throttle.

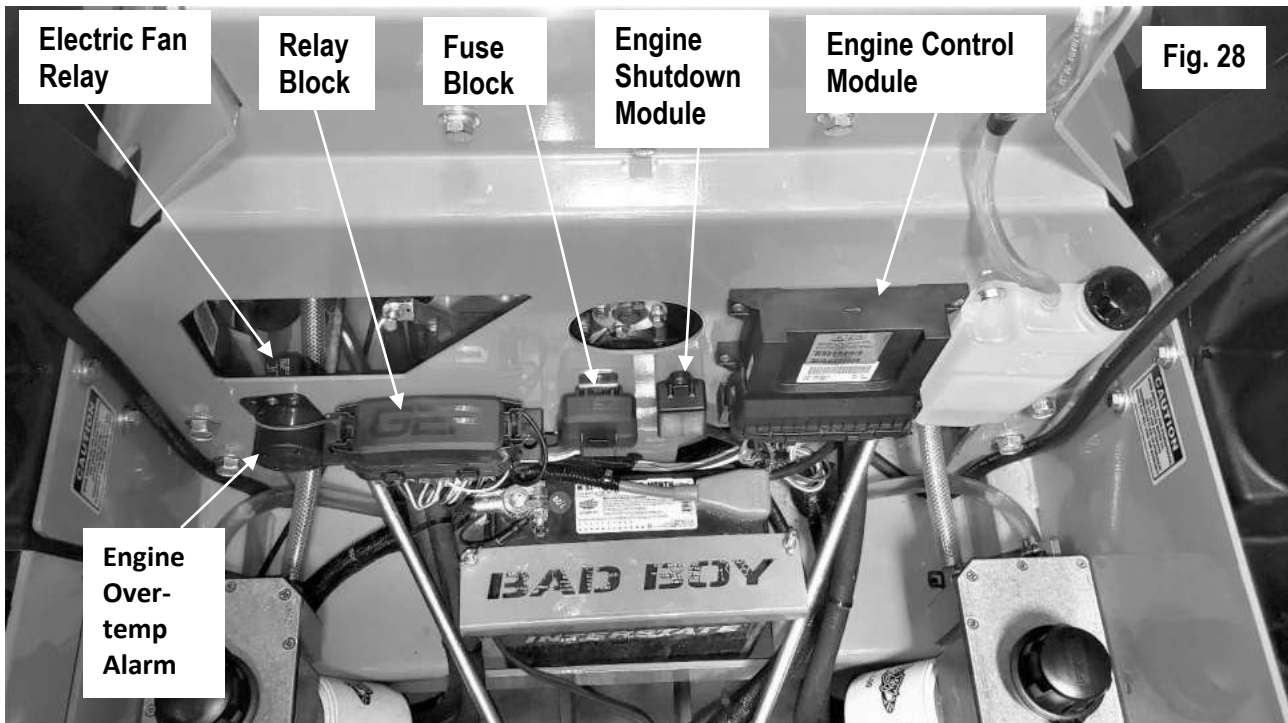
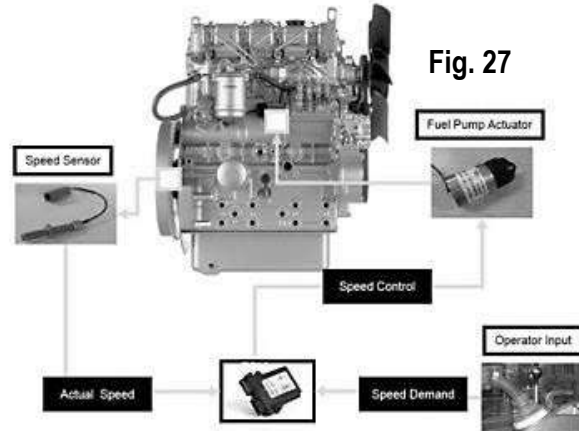





## SECTION 16: CASTER AND WHEEL

To access the recessed front fork nuts, remove the dust cap by prying gently using a flat-head screwdriver. Once cap is removed, a 1 7/16" socket will be needed for top nut. You will need to secure the bolt with a 1 1/2" wrench. The front fork nuts require a torque of 100ft.-lbs. Reapply the dust cap by gently tapping around its edges. Do NOT hit center of cap.

Torque rear wheel lugs to 65-75ft. lbs. Re-torque at every oil change and before each use.

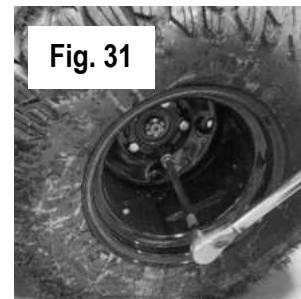
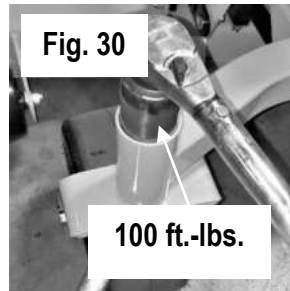
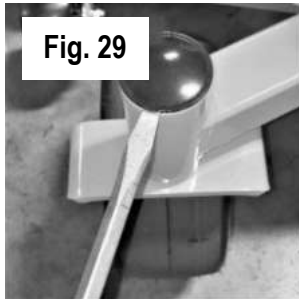

## SECTION 17: GREASE LOCATIONS

There are two grease fittings located on each of the two turnbuckles (4 total).

Grease at every oil change. Fig. 32.

The pump belt tensioner is located under the engine and has a grease fitting at its pivot. Grease at every engine oil change. Fig. 33.

The control arm actuators have grease fittings located on each tube.

Grease at every engine oil change. Fig. 34.

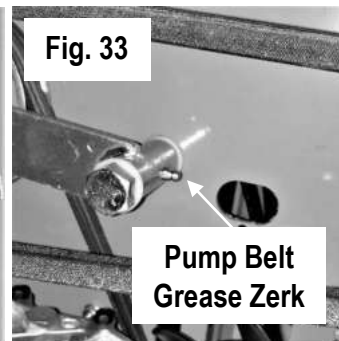
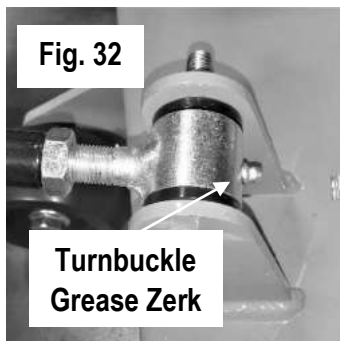

## SECTION 18: REAR SWING ARMS

There are 10 spherical rod ends located in the rear suspension system that do not require adjustment, but do require periodic inspection. Verify jam nuts are secured.

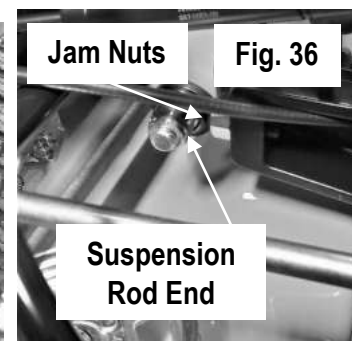
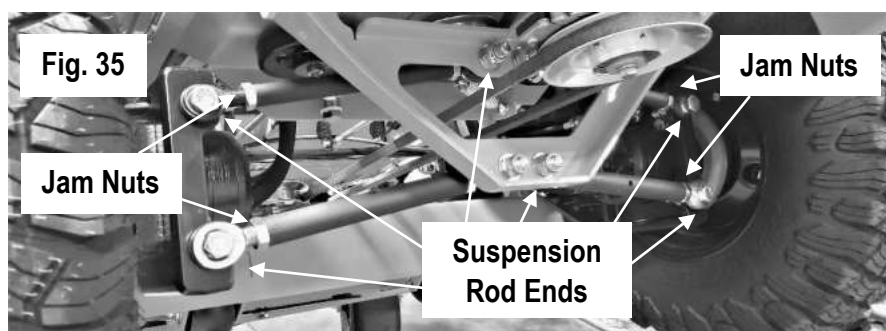

## SECTION 19: CUTTING DECK

### DECK BELT REMOVAL

1. Remove ignition key.
2. Raise the deck to its highest position.
3. Remove the pulley covers.
4. Remove belt retainer bolt.
5. Remove clutch bracket and pigtail.
6. While lifting up on the belt (as shown in Fig. 39.), rotate the pulley until the belt is free of the pulley. Exercise caution while performing this step as fingers can easily become caught between the belt and pulley.

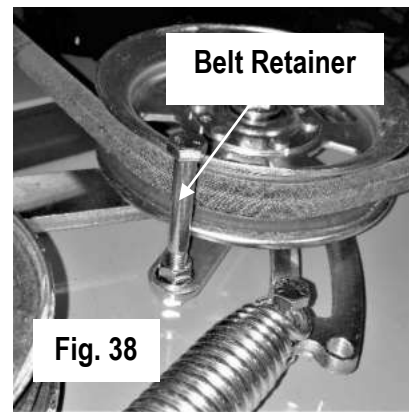
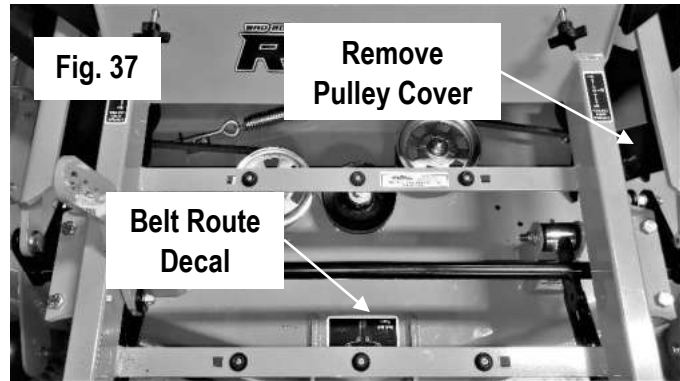

### DECK BELT INSTALLATION

1. Remove ignition key.
2. Raise the deck to its highest position. If needed loosen the deck belt tensioner to its weakest installed position.
3. Take off both pulley covers and route the belt by following the belt route decal. Verify that the belt is routed properly as improper routing can damage the spindles as well as the engine. Improper routing can also increase the potential personal injury hazard.
4. Install belt retainer bolt.
5. Install clutch bracket and pigtail.
6. Check belt tension and adjust if needed. See "ADJUST DECK BELT TENSION".
7. Reinstall both pulley covers.

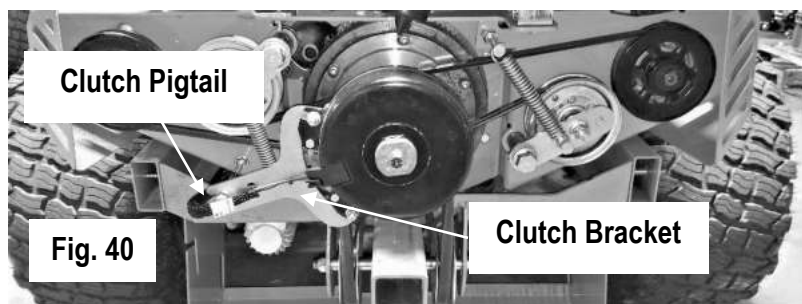

## ADJUST DECK BELT TENSION

The deck spring tension is critical. If the tension is too high, premature failure of the deck belt and blade spindles can occur. If the tension is too low, the belt can "jump off" or slip on the pulleys. This results in reduced cut quality and early belt failure.

Spring tension adjustments can be made by using a 9/16" wrench to adjust the two jam nuts, shown in Fig. 41. Belt tension should be 70-75 lbs. with the deck at its lowest cutting height. When tensioning a new belt recheck belt tension after 1/2 hour of cutting time.

Use a belt tension gauge to ensure the proper tension. Your dealer or service center will have a belt tension gauge or you can purchase one through the Bad Boy Mowers parts department at [866-622-3269](tel:866-622-3269) (Part Number 041-9999-00).

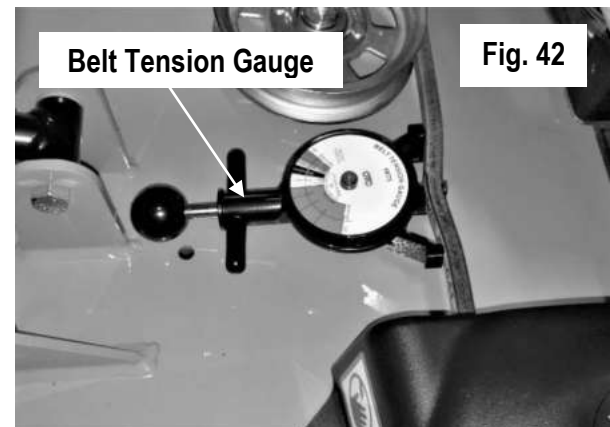

## BLADE SHARPENING

The blade on the top (Fig. 43) was utilized long after replacement was required. In addition to a decline in cut quality, failure to replace a worn or damaged blade creates a major safety hazard. Bad Boy recommends that blade sharpening be performed by a professional.

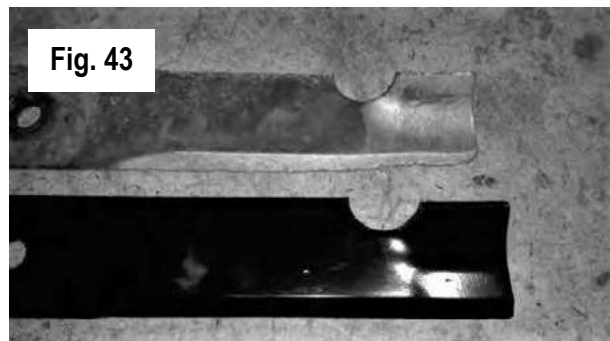



## LEVELING THE DECK

1. Start on a flat, level surface and set the air pressure in all four tires to 12 psi. Measure the deck at all four corners. The deck should be level from left to right but should be pitched downward front to back. The deck pitch is achieved by measuring from the cutting edge of the blade to the ground. Bad Boy recommends having a  $\frac{1}{4}$ " pitch down in the front measured from the cutting edge of the blade. Adjustments can be made by adjusting the deck hangers in their slots.
2. Using a pair of approximately 3 ft. long 2x4's, stand the boards on edge and slide them under the deck from front to back as shown in Fig. 44. Making sure the deck wheels and blade bolts do not rest on the 2x4's, and that the front and back edge of the deck rest on the 2x4's.
3. Lower the deck down onto the 2x4's using either the deck lift pedal or the electric actuator, whichever your mower is equipped with. The deck should now be approximately 3  $\frac{1}{2}$ " off the ground. to achieve the proper  $\frac{1}{4}$ " pitch down in the front it may be necessary to use some  $\frac{1}{4}$ " spacers under the rear of the deck as shown in Fig. 45.
4. Using a pair of 9/16" wrenches, loosen all deck hanger bolts on the top of the deck. These are the lower bolts in the slots of the deck as shown in Fig. 47. Do not loosen the upper bolts that attach the deck hangers to the actuator lift bars.
5. The deck is now loose from the frame and movement of the lift pedal or electric actuator should only move the hanger bolts up and down in the deck slots.
6. Set the deck dial to the 3.5 position, tighten all deck hanger bolts in their slots starting from the rear of the deck then moving to the front. Lift the deck to the highest position. Measure all four corners of the deck again to ensure that no further adjustments are necessary. The front of deck should be  $\frac{1}{4}$ " lower than rear of deck.
7. Remove 2x4s.

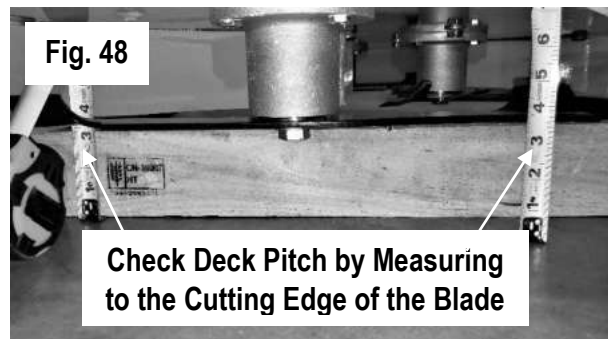
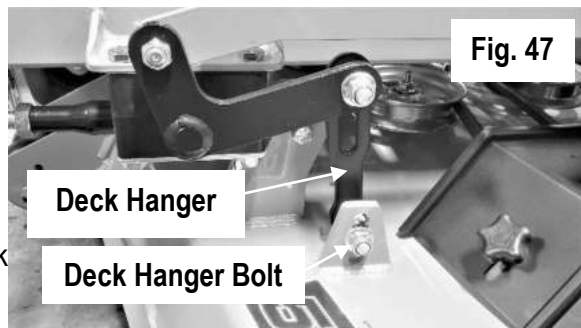
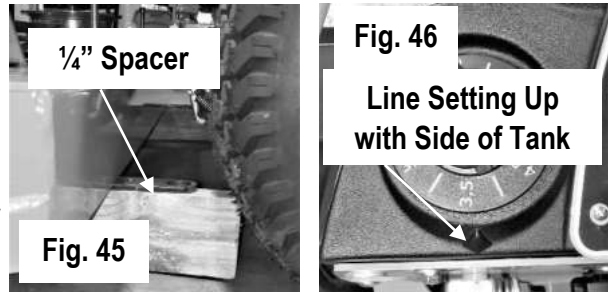
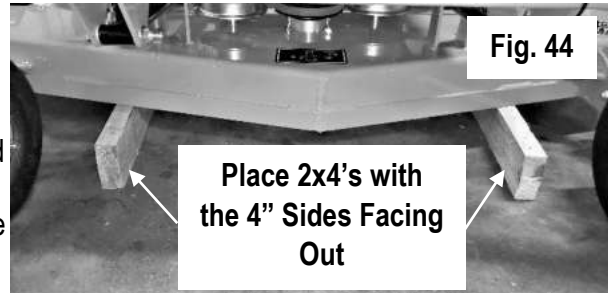



## BLADE REMOVAL

To change blades, it may be best to use a piece of wood positioned between the blade and mowing deck to keep the blade from turning. Use a 15/16" socket and Bad Boy recommends an impact wrench capable of and output torque of at least 220 ft-lbs. A box wrench and extension can be used, though component damage potential may be increased. The bolt has right-handed threads.

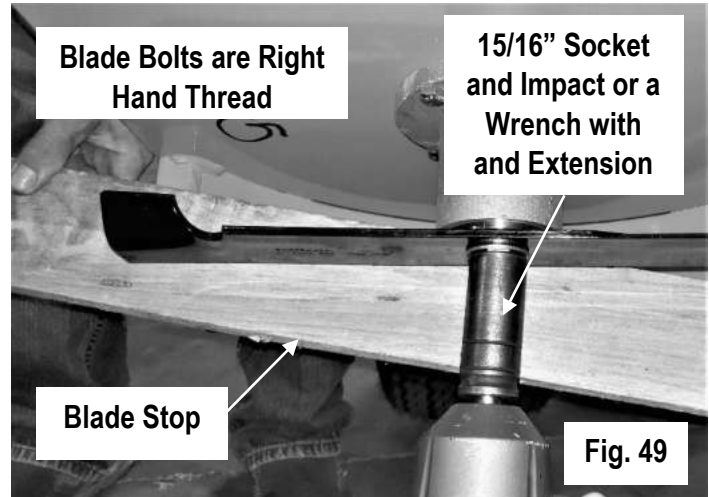

Re-torque the blade bolts to 90-110 ft-lbs. upon re-installation.

The blade spindles contain a sealed bearing inside the top and bottom of the spindle. The bearings are replaceable for a more cost-effective repair. Factors such as water introduction into the bearing will have a major impact on bearing life.

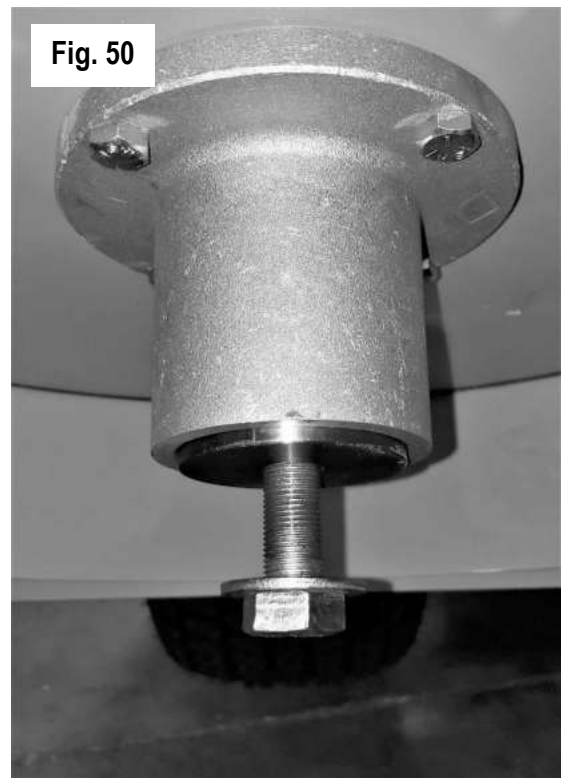



# MAINTENANCE LOG

<i>Date:</i>	<i>Hours:</i>	<i>Performed:</i>
<i>Date:</i>	<i>Hours:</i>	<i>Performed:</i>
<i>Date:</i>	<i>Hours:</i>	<i>Performed:</i>
<i>Date:</i>	<i>Hours:</i>	<i>Performed:</i>
<i>Date:</i>	<i>Hours:</i>	<i>Performed:</i>
<i>Date:</i>	<i>Hours:</i>	<i>Performed:</i>
<i>Date:</i>	<i>Hours:</i>	<i>Performed:</i>
<i>Date:</i>	<i>Hours:</i>	<i>Performed:</i>
<i>Date:</i>	<i>Hours:</i>	<i>Performed:</i>
<i>Date:</i>	<i>Hours:</i>	<i>Performed:</i>
<i>Date:</i>	<i>Hours:</i>	<i>Performed:</i>
<i>Date:</i>	<i>Hours:</i>	<i>Performed:</i>
<i>Date:</i>	<i>Hours:</i>	<i>Performed:</i>
<i>Date:</i>	<i>Hours:</i>	<i>Performed:</i>
<i>Date:</i>	<i>Hours:</i>	<i>Performed:</i>
<i>Date:</i>	<i>Hours:</i>	<i>Performed:</i>
<i>Date:</i>	<i>Hours:</i>	<i>Performed:</i>
<i>Date:</i>	<i>Hours:</i>	<i>Performed:</i>
<i>Date:</i>	<i>Hours:</i>	<i>Performed:</i>
<i>Date:</i>	<i>Hours:</i>	<i>Performed:</i>
<i>Date:</i>	<i>Hours:</i>	<i>Performed:</i>
<i>Date:</i>	<i>Hours:</i>	<i>Performed:</i>
<i>Date:</i>	<i>Hours:</i>	<i>Performed:</i>
<i>Date:</i>	<i>Hours:</i>	<i>Performed:</i>



## 2021 LIMITED WARRANTY FOR BAD BOY COMMERCIAL MOWER

**(WALK-BEHIND, COMPACT OUTLAW, REVOLT, REBEL, ROGUE, and RENEGADE)**

### 1. WHAT THIS WARRANTY COVERS, AND FOR HOW LONG:

Bad Boy, Inc. will, at its option, repair or replace, without charge, any part covered by the warranty which is found to be defective in material and/or workmanship for two (2) years \* after the date of sale to the original retail purchaser unless the product is used for rental purposes, in which case this warranty is limited to ninety (90) days.

The leading edge of the deck shell will be warranted for the entire lifetime of the machine to the original purchaser against defects in materials and workmanship. Labor required to repair or replace the leading edge of the deck shell will be covered by Bad Boy Inc. for two years and at the unit owner's expense during the balance of the lifetime of the machine.

Belts are warranted for a period of ninety (90) days against materials or workmanship defects.

Non-suspension seats are warranted for a period of (2) years against material or workmanship defects.

Suspension seats are warranted for a period of (1) year against material or workmanship defects.

At Bad Boy, Inc.'s request, customer will make the defective part available for inspection by Bad Boy, Inc. and/or return the defective part to Bad Boy, Inc., transportation charges prepaid.

### 2. WHAT THIS WARRANTY DOES NOT COVER:

- A. This warranty does not cover defects caused by depreciation or damage caused by normal wear, accidents, improper maintenance, improper use or abuse of the product, alterations, or failure to follow the instruction contained in the Owner's Manual for operation and maintenance.
- B. The customer shall pay any charges for making service calls and/or for transporting the mower to and from the place where the inspection and/or warranty work is performed.  
**Bad Boy Inc will not be responsible for the pickup and delivery of a machine for warranty purposes.**
- C. Engines are warranted separately by their respective manufacturer. The available warranties covering this item are furnished with each mower. Bad Boy, Inc does not assume any warranty obligation, liability or modification for this item, which is covered exclusively by the stated warranty of the respective manufacturers.
- D. Tires, blades, deck anti-scalping wheels, and dust covers are considered to be consumable wear items and are therefore not warranted.
- E. Batteries are warranted for six months (free replacement) from the retail purchase date against materials or workmanship defects. The battery warranty must be obtained through the battery manufacturer.
- F. Normal maintenance services such as oil change, cleaning, lubrication, adjustment.
- G. Replacement of services, items, such as oil, lubricants, spark plugs, belts, rubber hoses or other items subject to normal service replacement.

### 3. HOW TO OBTAIN SERVICE UNDER THIS WARRANTY:

- A. Warranty service can be arranged by contacting the dealer where you purchased the mower. Proof of the date of purchase may be required to verify warranty coverage. Warranty repairs must be completed by an authorized Bad Boy center.
- B. **Warranty claims will not be reviewed or paid unless the warranty registration is received by Bad Boy, Inc. within 30 days of the retail purchase date.**
- C. Warranty claims requiring parts returned will be settled upon return of parts to Bad Boy for inspection.
- D. All warranty issues must be handled through an authorized service center or dealership.

### 4. WARRANTY LIMITATION:

- A. **THERE IS NO OTHER EXPRESS WARRANTY. ANY WARRANTY THAT MAY BE IMPLIED FROM THIS PURCHASE INCLUDING MERCHANTABILITY AND FITNESS FOR A PARTICULAR PURPOSE IS HEREBY LIMITED TO THE DURATION OF THIS WARRANTY AND TO THE EXTENT PERMITTED BY LAW ANY AND ALL IMPLIED WARRANTIES ARE EXCLUDED.** Some states do not allow limitations on how long an implied warranty lasts, so the above limitations may not apply to you.
- B. **BAD BOY, INC. WILL NOT BE LIABLE FOR ANY INCIDENTAL, CONSEQUENTIAL, OR SPECIAL DAMAGES AND/OR EXPENSES IN CONNECTION WITH THE PURCHASE OR USE OF THE MOWER.** Some states do not allow the exclusion or limitation of incidental or consequential damages, so the above limitation(s) or exclusion(s) may not apply to you.
- C. Only the warranty expressed in this limited warranty shall apply and no dealer, distributor, or individual is authorized to amend, modify, or extend this warranty in any way. Accordingly, additional statements such as dealer advertising or presentations, whether oral or written, do not constitute warranties by Bad boy, Inc., and should not be relied on.
- D. This warranty extends only to turf equipment operated under normal conditions and properly serviced and maintained. The warranty expressly does not cover (i) any defects, damage or deterioration due to normal use, wear and tear, or exposure; (ii) normal maintenance services such as oil change, cleaning, lubrication, adjustment; (iii) replacement of services, items, such as oil, lubricants, spark plugs, belts, rubber hoses or other items subject to normal service replacement; (iv) damage or defects arising out of or relating to misuse, neglect, alteration, negligence or accident; (v) repair or replacement arising from operation of or use of the turf equipment which is not in accordance with operating instructions as specified in the operator's manual or other operational instructions provided by Bad Boy Inc.; (vi) repair or replacement arising as a result of any operation from turf equipment that has been altered or modified so as to, indetermination of Bad Boy, Inc., adversely affect the operation, performance or durability of the equipment or that has altered, modified or affected the turf equipment so as to change the intended use of the product; (vii) repair or replacement necessitated by use of parts, accessories or supplies, including gasoline, oil or lubricants, incompatible with the turf equipment or other than as recommended in the operator's manual or other operational instructions provided by Bad Boy, Inc.; (viii) repairs or replacements resulting from parts or accessories which have adversely affected the operation, performance or durability of the turf equipment; or (ix) damage or defects due to or arising out of repair of turf equipment by person or persons other than an authorized Bad Boy, Inc., service dealer or the installation of parts other than genuine Bad Boy, Inc., recommended parts.  
**As a condition to this warranty, customer shall have read the operator's manual and ensured the mower has been registered within 30 days of purchase.**
- E. This warranty gives you specific legal rights, and you may also have other rights, which vary from state to state.



**BAD BOY, INC.**

**102 INDUSTRIAL DRIVE**

**BATESVILLE, AR 72501**

**WWW.BADBOYMOWERS.COM**

Technical Support:.....techsupport@badboymowers.com

Warranty: .....warranty@badboymowers.com

Parts:.....partsdept@badboymowers.com

## **WARRANTY REGISTRATION**

Ensure selling dealership has registered mower within  
30 days of purchase to validate warranty.

Please record your serial number, date of purchase and dealership information  
for your records.

Serial # \_\_\_\_\_

Date of Purchase \_\_\_\_\_

Dealer Information \_\_\_\_\_











**BAD BOY  
MOWERS**

**[www.badboymowers.com](http://www.badboymowers.com)**

Bad Boy, Inc.

102 Industrial Drive

Batesville, Arkansas 72501